

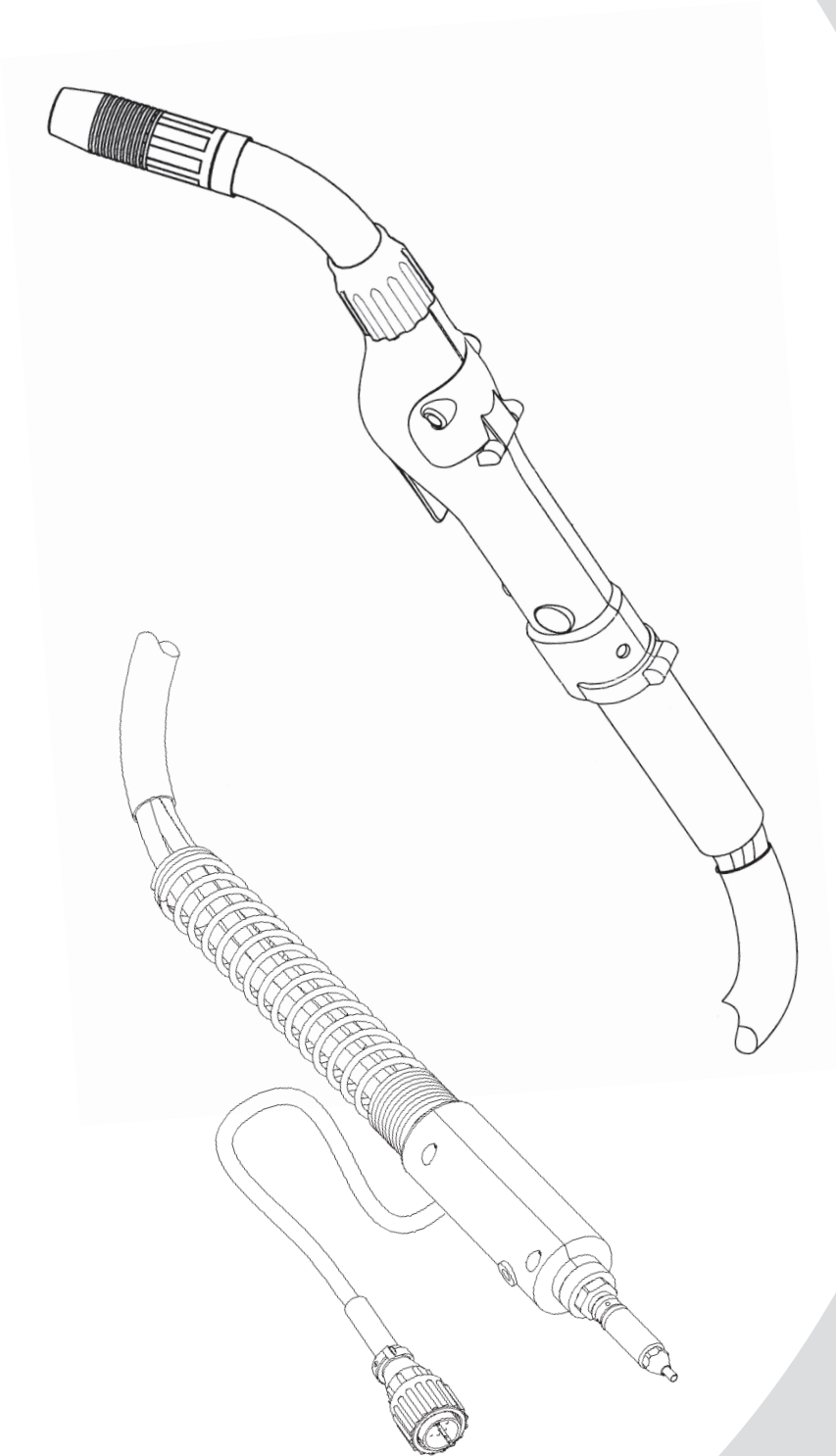

PYTHON[®]
Millermatic Compatible™

Owner's Manual

Product:	Python
Manual:	091-0593
Serial:	08050001
Voltage Rating:	24 VDC
Revision:	May 2008 Rev B
Gun models:	240-8xx



225 Ampere Push-Pull Welding Gun

Table of Contents

Safety Considerations	i-iii
-----------------------------	-------

Installation	Section A
--------------------	-----------

Technical Specifications	1
Support Equipment Required	1
Gun Lead Connections	1
Coolant Recommendations	1

Operation	Section B
-----------------	-----------

General	2
Controls and Settings	2
Trigger Adjustment	2
Drive Roll and Idler Rolls	2

Accessories	Section C
-------------------	-----------

Insulated Drive Roll Kits	3
Replacement Kits	4
Snake Skins	4
Contact Tips	4
Barrels	4

Maintenance	Section D
-------------------	-----------

Periodic Maintenance	5
Recommended Spare Parts List	6

Troubleshooting	Section E
-----------------------	-----------

Troubleshooting Guide	6
Testing The Gun	6

Appendices	Section F
------------------	-----------

Diagrams / Parts List	9
Mechanical	10
Electrical	17

Warranty

Declaration of Conformity for European Community (CE) Products

Note  This information is provided for units with CE certification (see rating label on unit).

Manufacturer's Name: **MK Products, Inc.**

Manufacturer's Address: 16882 Armstrong Ave.
Irvine, CA 92606

Declares that the product: **Python®**

conforms to the following Directives and Standards:

Directives

Low Voltage Directive: 73/23/EEC

Electromagnetic Compatibility (EMC) Directive: 89/336/EEC

Standards

Arc Welding Equipment Part I: Welding Power Sources: IEC 60974-1
(September 1998 – Second Edition)

Arc Welding Equipment: Wirefeed Systems: IEC 974-5
(September 1997 – Draft Revision)

Degrees of Protection Provided By Enclosures (IP Code): IEC 529:1989
(November 1989 - First Edition)

Insulation Coordination For Equipment With Low-Voltage Systems:
Part I: Principles, Requirements and Tests: IEC 664-1: 1992
(October 1992 – First Edition)

Electromagnetic Compatibility, (EMC): EN 50199
(August 1995)

Torches And Guns For Arc Welding, EN 50078

SECTION 1 – SAFETY PRECAUTIONS - READ BEFORE USING

som_nd_7/02

1-1. Symbol Usage



Means Warning! Watch Out! There are possible hazards with this procedure! The possible hazards are shown in the adjoining symbols.

▲ Marks a special safety message.

☞ Means "Note"; not safety related.



This group of symbols means Warning! Watch Out! possible ELECTRIC SHOCK, MOVING PARTS, and HOT PARTS hazards. Consult symbols and related instructions below for necessary actions to avoid the hazards.

1-2. Arc Welding Hazards

▲ The symbols shown below are used throughout this manual to call attention to and identify possible hazards. When you see the symbol, watch out, and follow the related instructions to avoid the hazard. The safety information given below is only a summary of the more complete safety information found in the Safety Standards listed in Section 1-4. Read and follow all Safety Standards.

▲ Only qualified persons should install, operate, maintain, and repair this unit.

▲ During operation, keep everybody, especially children, away.



ELECTRIC SHOCK can kill.

Touching live electrical parts can cause fatal shocks or severe burns. The electrode and work circuit is electrically live whenever the output is on. The input power circuit and machine internal circuits are also live when power is on. In semiautomatic or automatic wire welding, the wire, wire reel, drive roll housing, and all metal parts touching the welding wire are electrically live. Incorrectly installed or improperly grounded equipment is a hazard.

- Do not touch live electrical parts.
- Wear dry, hole-free insulating gloves and body protection.
- Insulate yourself from work and ground using dry insulating mats or covers big enough to prevent any physical contact with the work or ground.
- Do not use AC output in damp areas, if movement is confined, or if there is a danger of falling.
- Use AC output ONLY if required for the welding process.
- If AC output is required, use remote output control if present on unit.
- Disconnect input power or stop engine before installing or servicing this equipment. Lockout/tagout input power according to OSHA 29 CFR 1910.147 (see Safety Standards).
- Properly install and ground this equipment according to its Owner's Manual and national, state, and local codes.
- Always verify the supply ground – check and be sure that input power cord ground wire is properly connected to ground terminal in disconnect box or that cord plug is connected to a properly grounded receptacle outlet.
- When making input connections, attach proper grounding conductor first – double-check connections.
- Frequently inspect input power cord for damage or bare wiring – replace cord immediately if damaged – bare wiring can kill.
- Turn off all equipment when not in use.
- Do not use worn, damaged, undersized, or poorly spliced cables.
- Do not drape cables over your body.

- If earth grounding of the workpiece is required, ground it directly with a separate cable.
- Do not touch electrode if you are in contact with the work, ground, or another electrode from a different machine.
- Use only well-maintained equipment. Repair or replace damaged parts at once. Maintain unit according to manual.
- Wear a safety harness if working above floor level.
- Keep all panels and covers securely in place.
- Clamp work cable with good metal-to-metal contact to workpiece or worktable as near the weld as practical.
- Insulate work clamp when not connected to workpiece to prevent contact with any metal object.
- Do not connect more than one electrode or work cable to any single weld output terminal.

SIGNIFICANT DC VOLTAGE exists after removal of input power on inverters.

- Turn Off inverter, disconnect input power, and discharge input capacitors according to instructions in Maintenance Section before touching any parts.

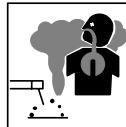

FUMES AND GASES can be hazardous.

Welding produces fumes and gases. Breathing these fumes and gases can be hazardous to your health.

- Keep your head out of the fumes. Do not breathe the fumes.
- If inside, ventilate the area and/or use exhaust at the arc to remove welding fumes and gases.
- If ventilation is poor, use an approved air-supplied respirator.
- Read the Material Safety Data Sheets (MSDSs) and the manufacturer's instructions for metals, consumables, coatings, cleaners, and degreasers.
- Work in a confined space only if it is well ventilated, or while wearing an air-supplied respirator. Always have a trained watchperson nearby. Welding fumes and gases can displace air and lower the oxygen level causing injury or death. Be sure the breathing air is safe.
- Do not weld in locations near degreasing, cleaning, or spraying operations. The heat and rays of the arc can react with vapors to form highly toxic and irritating gases.
- Do not weld on coated metals, such as galvanized, lead, or cadmium plated steel, unless the coating is removed from the weld area, the area is well ventilated, and if necessary, while wearing an air-supplied respirator. The coatings and any metals containing these elements can give off toxic fumes if welded.



ARC RAYS can burn eyes and skin.

Arc rays from the welding process produce intense visible and invisible (ultraviolet and infrared) rays that can burn eyes and skin. Sparks fly off from the weld.

- Wear a welding helmet fitted with a proper shade of filter to protect your face and eyes when welding or watching (see ANSI Z49.1 and Z87.1 listed in Safety Standards).
- Wear approved safety glasses with side shields under your helmet.
- Use protective screens or barriers to protect others from flash and glare; warn others not to watch the arc.
- Wear protective clothing made from durable, flame-resistant material (leather and wool) and foot protection.



WELDING can cause fire or explosion.

Welding on closed containers, such as tanks, drums, or pipes, can cause them to blow up. Sparks can fly off from the welding arc. The flying sparks, hot workpiece, and hot equipment can cause fires and burns. Accidental contact of electrode to metal objects can cause sparks, explosion, overheating, or fire. Check and be sure the area is safe before doing any welding.

- Protect yourself and others from flying sparks and hot metal.
- Do not weld where flying sparks can strike flammable material.
- Remove all flammables within 35 ft (10.7 m) of the welding arc. If this is not possible, tightly cover them with approved covers.
- Be alert that welding sparks and hot materials from welding can easily go through small cracks and openings to adjacent areas.
- Watch for fire, and keep a fire extinguisher nearby.
- Be aware that welding on a ceiling, floor, bulkhead, or partition can cause fire on the hidden side.
- Do not weld on closed containers such as tanks, drums, or pipes, unless they are properly prepared according to AWS F4.1 (see Safety Standards).
- Connect work cable to the work as close to the welding area as practical to prevent welding current from traveling long, possibly unknown paths and causing electric shock and fire hazards.
- Do not use welder to thaw frozen pipes.
- Remove stick electrode from holder or cut off welding wire at contact tip when not in use.
- Wear oil-free protective garments such as leather gloves, heavy shirt, cuffless trousers, high shoes, and a cap.
- Remove any combustibles, such as a butane lighter or matches, from your person before doing any welding.

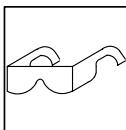

FLYING METAL can injure eyes.

- Welding, chipping, wire brushing, and grinding cause sparks and flying metal. As welds cool, they can throw off slag.
- Wear approved safety glasses with side shields even under your welding helmet.



BUILDUP OF GAS can injure or kill.

- Shut off shielding gas supply when not in use.
- Always ventilate confined spaces or use approved air-supplied respirator.



HOT PARTS can cause severe burns.

- Do not touch hot parts bare handed.
- Allow cooling period before working on gun or torch.

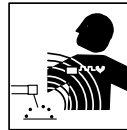

MAGNETIC FIELDS can affect pacemakers.

- Pacemaker wearers keep away.
- Wearers should consult their doctor before going near arc welding, gouging, or spot welding operations.

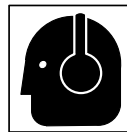

NOISE can damage hearing.

Noise from some processes or equipment can damage hearing.

- Wear approved ear protection if noise level is high.

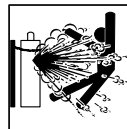

CYLINDERS can explode if damaged.

Shielding gas cylinders contain gas under high pressure. If damaged, a cylinder can explode. Since gas cylinders are normally part of the welding process, be sure to treat them carefully.

- Protect compressed gas cylinders from excessive heat, mechanical shocks, slag, open flames, sparks, and arcs.
- Install cylinders in an upright position by securing to a stationary support or cylinder rack to prevent falling or tipping.
- Keep cylinders away from any welding or other electrical circuits.
- Never drape a welding torch over a gas cylinder.
- Never allow a welding electrode to touch any cylinder.
- Never weld on a pressurized cylinder – explosion will result.
- Use only correct shielding gas cylinders, regulators, hoses, and fittings designed for the specific application; maintain them and associated parts in good condition.
- Turn face away from valve outlet when opening cylinder valve.
- Keep protective cap in place over valve except when cylinder is in use or connected for use.
- Read and follow instructions on compressed gas cylinders, associated equipment, and CGA publication P-1 listed in Safety Standards.

1-3. Additional Symbols For Installation, Operation, And Maintenance



FIRE OR EXPLOSION hazard.

- Do not install or place unit on, over, or near combustible surfaces.
- Do not install unit near flammables.
- Do not overload building wiring – be sure power supply system is properly sized, rated, and protected to handle this unit.



MOVING PARTS can cause injury.

- Keep away from moving parts such as fans.
- Keep all doors, panels, covers, and guards closed and securely in place.



FALLING UNIT can cause injury.

- Use lifting eye to lift unit only, NOT running gear, gas cylinders, or any other accessories.
- Use equipment of adequate capacity to lift and support unit.
- If using lift forks to move unit, be sure forks are long enough to extend beyond opposite side of unit.

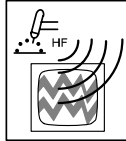

H.F. RADIATION can cause interference.

- High-frequency (H.F.) can interfere with radio navigation, safety services, computers, and communications equipment.
- Have only qualified persons familiar with electronic equipment perform this installation.
- The user is responsible for having a qualified electrician promptly correct any interference problem resulting from the installation.
- If notified by the FCC about interference, stop using the equipment at once.
- Have the installation regularly checked and maintained.
- Keep high-frequency source doors and panels tightly shut, keep spark gaps at correct setting, and use grounding and shielding to minimize the possibility of interference.

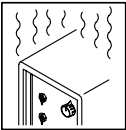

OVERUSE can cause OVERHEATING

- Allow cooling period; follow rated duty cycle.
- Reduce current or reduce duty cycle before starting to weld again.
- Do not block or filter airflow to unit.

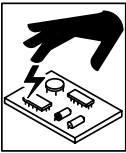

STATIC (ESD) can damage PC boards.

- Put on grounded wrist strap BEFORE handling boards or parts.
- Use proper static-proof bags and boxes to store, move, or ship PC boards.



MOVING PARTS can cause injury.

- Keep away from moving parts.
- Keep away from pinch points such as drive rolls.

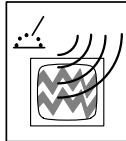

ARC WELDING can cause interference.

- Electromagnetic energy can interfere with sensitive electronic equipment such as computers and computer-driven equipment such as robots.
- Be sure all equipment in the welding area is electromagnetically compatible.
- To reduce possible interference, keep weld cables as short as possible, close together, and down low, such as on the floor.
- Locate welding operation 100 meters from any sensitive electronic equipment.
- Be sure this welding machine is installed and grounded according to this manual.
- If interference still occurs, the user must take extra measures such as moving the welding machine, using shielded cables, using line filters, or shielding the work area.



WELDING WIRE can cause injury.

- Do not press gun trigger until instructed to do so.
- Do not point gun toward any part of the body, other people, or any metal when threading welding wire.

1-4. Principal Safety Standards

Safety in Welding, Cutting, and Allied Processes, ANSI Standard Z49.1, from American Welding Society, 550 N.W. LeJeune Rd, Miami FL 33126 (phone: 305-443-9353, website: www.aws.org).

Recommended Safe Practices for the Preparation for Welding and Cutting of Containers and Piping, American Welding Society Standard AWS F4.1, from American Welding Society, 550 N.W. LeJeune Rd, Miami, FL 33126 (phone: 305-443-9353, website: www.aws.org).

National Electrical Code, NFPA Standard 70, from National Fire Protection Association, P.O. Box 9101, 1 Battery March Park, Quincy, MA 02269-9101 (phone: 617-770-3000, website: www.nfpa.org and www.sparky.org).

Safe Handling of Compressed Gases in Cylinders, CGA Pamphlet P-1, from Compressed Gas Association, 1735 Jefferson Davis Highway, Suite 1004, Arlington, VA 22202-4102 (phone: 703-412-0900, website: www.cganet.com).

Code for Safety in Welding and Cutting, CSA Standard W117.2, from Canadian Standards Association, Standards Sales, 178 Rexdale

Boulevard, Rexdale, Ontario, Canada M9W 1R3 (phone: 800-463-6727 or in Toronto 416-747-4044, website: www.csa-international.org).

Practice For Occupational And Educational Eye And Face Protection, ANSI Standard Z87.1, from American National Standards Institute, 11 West 42nd Street, New York, NY 10036-8002 (phone: 212-642-4900, website: www.ansi.org).

Standard for Fire Prevention During Welding, Cutting, and Other Hot Work, NFPA Standard 51B, from National Fire Protection Association, P.O. Box 9101, 1 Battery March Park, Quincy, MA 02269-9101 (phone: 617-770-3000, website: www.nfpa.org and www.sparky.org).

OSHA, Occupational Safety and Health Standards for General Industry, Title 29, Code of Federal Regulations (CFR), Part 1910, Subpart Q, and Part 1926, Subpart J, from U.S. Government Printing Office, Superintendent of Documents, P.O. Box 371954, Pittsburgh, PA 15250 (there are 10 Regional Offices—phone for Region 5, Chicago, is 312-353-2220, website: www.osha.gov).

1-5. EMF Information

Considerations About Welding And The Effects Of Low Frequency Electric And Magnetic Fields

Welding current, as it flows through welding cables, will cause electromagnetic fields. There has been and still is some concern about such fields. However, after examining more than 500 studies spanning 17 years of research, a special blue ribbon committee of the National Research Council concluded that: "The body of evidence, in the committee's judgment, has not demonstrated that exposure to power-frequency electric and magnetic fields is a human-health hazard." However, studies are still going forth and evidence continues to be examined. Until the final conclusions of the research are reached, you may wish to minimize your exposure to electromagnetic fields when welding or cutting.

To reduce magnetic fields in the workplace, use the following procedures:

1. Keep cables close together by twisting or taping them.
2. Arrange cables to one side and away from the operator.
3. Do not coil or drape cables around your body.
4. Keep welding power source and cables as far away from operator as practical.
5. Connect work clamp to workpiece as close to the weld as possible.

About Pacemakers:

Pacemaker wearers consult your doctor first. If cleared by your doctor, then following the above procedures is recommended.

SECTION 2 – DEFINITIONS





















2-1. Warning Label Definitions

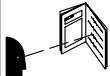

- A. Warning! Watch Out! There are possible hazards as shown by the symbols.
- B. Drive rolls can injure fingers.
- C. Welding wire and drive parts are at welding voltage during operation – keep hands and metal objects clear.
- 1 Electric shock can kill.
 - 1.1 Wear dry insulating gloves. Do not touch electrode with bare hand. Do not wear wet or damaged gloves.
 - 1.2 Protect yourself from electric shock by insulating yourself from work and ground.
 - 1.3 Disconnect input plug or power before working on machine.
 - 2 Breathing welding fumes can be hazardous to your health.
 - 2.1 Keep your head out of the fumes.
 - 2.2 Use forced ventilation or local exhaust to remove the fumes.
 - 2.3 Use ventilating fan to remove fumes.
 - 3 Welding sparks can cause explosion or fire.
 - 3.1 Keep flammables away from welding. Don't weld near flammables.
 - 3.2 Welding sparks can cause fires. Have a fire extinguisher nearby and have a watch person ready to use it.
 - 3.3 Do not weld on drums or any closed containers.
 - 4 Arc rays can burn eyes and injure skin.
 - 4.1 Wear hat and safety glasses. Use ear protection and button shirt collar. Use welding helmet with correct shade of filter. Wear complete body protection.
 - 5 Become trained and read the instructions before working on the machine or welding.
 - 6 Do not remove or paint over (cover) the label.

2-3. Symbols And Definitions

Note  Some symbols are found only on CE products.

A	Amperes	V	Volts		Alternating Current	X	Duty Cycle
IP	Degree Of Protection	Hz	Hertz		Circuit Breaker		Wire Feed
	Jog		Output		Trigger		Gun
	Press To Set		Increase		Trigger Hold On		Trigger Hold Off
	Purge		Spot Weld Time	%	Percent		Run-In
	Burnback Time	U₁	Primary Voltage	U₂	Load Voltage		Read Instructions
I₁	Primary Current	I₂	Rated Current		Line Connection		Water (Coolant) In-put
	Water (Coolant) Output		Fuse		Continuous Spot Welding		

Thank You

For selecting a quality product. We want you to take pride in operating this product...as much pride as we have in bringing the product to you!

Please Examine Carton and Equipment For Damage Immediately

When this equipment is shipped, title passes to the purchaser upon receipt by the carrier. Consequently, claims for material damaged in shipment must be made by the purchaser against the transportation company at the time the shipment is received.

Please record your equipment identification information below for future reference. This information can be found on your machine nameplate.

Model Name & Number _____

Code & Serial Number _____

Date of Purchase _____

Whenever you request replacements parts for, or information on this equipment always supply the information you have recorded above.

Read this Owner's Manual completely before attempting to use this equipment. Save this manual and keep it handy for quick reference. Pay particular attention to the safety instructions we have provided for your protection.

This page intentionally blank

Section A



Installation



Technical Specifications

Wire Capacity

Aluminum and Cored Wire **.030" - 1/16" (0.8 mm - 1.6 mm)**
Solid and Hard Wire **.030" - .045" (0.6 mm - 1.2 mm)**

Wire Speed (*At rated feeder input voltage*) **70 - 875 ipm (22.2 mpm)**

Duty Cycle - 60% (*All ratings are using Argon gas*) **225 Amps Peak**

Shipping Weight (approximate) **19.29 lbs. (8.29 Kg)**

Gun weight (less leads)..... **2.5 lbs. (1.13 Kg)**

Support Equipment Required

- C.V. or C.C. power source of sufficient capacity for your needs.
- Regulated gas supply and hoses.
- Properly sized power leads from power source to wire feeder and ground.

Gun Lead Connections

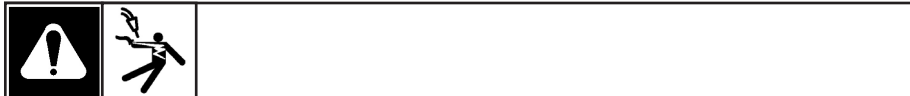

Power Cable

A #2 AWG power cable is used on the Millermatic Compatible™ Python®. The gun end of the cable has a fitting crimped to the copper cable strands. This fitting is then threaded into the gun body. The cabinet end of the power cable is incorporated into the Power Pin connector.

The power cable gun end is a threaded fitting which screws into the gun body. The cabinet end is secured in the central body with a set screw. These connections utilize a conductive sealant and are tightened to a specific torque setting (reference exploded parts drawing in the Appendix for details).

Conduit

The Millermatic Compatible™ Python® comes standard with a poly-lined conduit, for feeding aluminum wire. The longer fitting with a shallow groove is used on the gun end. A set screw located on top of the gun handle secures the conduit in place. The cabinet end of the conduit is secured into the Power Pin connector with a set screw.

Gas Hose

The gas hose is pushed over barbed fittings on both gun body and the Power Pin connector and is secured with a plastic tie wrap.

Electric Cable

A multi-conductor control cable is used on the Millermatic Compatible™ Python®. The gun end of the cable is secured with a cable clamp and the wires are connected to the potentiometer, the micro switch, the motor and the gun body mechanically. Slack is left in the electric cable as it exits the back of the gun to prevent cable and/or wire breakage. The cabinet end of the control cable uses a 10-Pin, "X" clocked Amphenol connector.

Section B

Operation

General

The Python® maintains a constant, steady, uniform wire feed speed, regardless of curved or looped wire conduit. The constant push exerted by the slave motor in the cabinet, combined with the pull of the gun motor, causes the wire to literally float friction-free through the wire conduit. The 24VDC gun motor is controlled by a three and three-quarter (3 3/4) turn potentiometer in the gun handle.

Controls and Settings



Potentiometer

The laterally-positioned potentiometer is located in the lower end of the handle, providing up to 875 ipm (22.2 mpm) with 3 3/4 turns.

Micro Switch

The micro switch assembly consists of a normally open micro switch and solder-attached leads.

Trigger Sensitivity

The amount of trigger level travel can be shortened for a quicker or more responsive action.

A more sensitive trigger lever is produced by reducing the gap between the trigger lever and the micro switch lever. By turning-in the trigger sensitivity adjustment screw, it closed the gap between the trigger lever and the micro switch lever.

This will enable the operator to increase the sensitivity of the trigger lever.

Sensitivity Adjustment

With the wire feeder turned on (with or without welding wire loaded), turn the screw in until the micro-switch is activated. Once activated, the gun and wire feeder motors will begin feeding wire. Retract the screw accordingly until the system is deactivated and adjusted to the operators' liking.

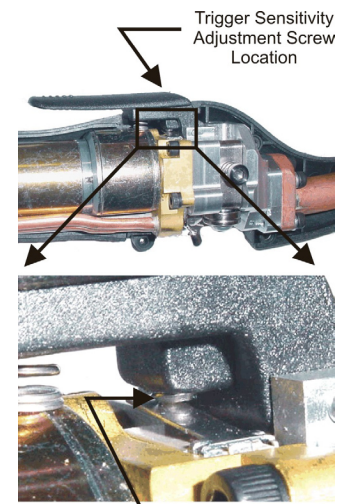

Screw adjusted out of trigger, pre-setting the micro-switch lever for shorter trigger motion sensitivity.

Drive Roll and Idler Rolls



The Millermatic Compatible™ Python® comes standard with a knurled drive roll and a grooved idler roll, which will handle both steel and aluminum wire with diameters from .030-1/16 inch aluminum and .030-.045 solid and hard wire. Optional insulated V-groove drive rolls are also available for aluminum wire if desired (see optional kits).

Drive roll tension is accomplished with a unique spring-loaded pressure screw. The Python® comes from the factory with the pressure adjustment screw preset.

NO ADJUSTMENT REQUIRED FOR ANY WIRE SIZE AND ALLOY

Drive Roll Installation/Removal

Note: Neither of the handles needs to be removed to access the drive or idler rolls.

1. Pull the cam lever away from the idler roll. This will relieve the pressure against the drive roll (as shown in Figure 1).
2. Align the drive roll removal tool over the flats of the drive roll (as shown in Figure 2). Hold the gun with one hand or on a table top, with the other hand give the removal tool a quick snap-turn in the **CLOCKWISE DIRECTION**.
3. Once the drive roll is loose, continue to spin drive roll in the clockwise direction to remove the drive roll from the gun.
4. Install a new drive roll on the left-hand threaded shaft. The drive roll will self-tighten when it is feeding wire.



Figure 1



Figure 2

Idler Roll Installation and Removal

(Reference Figure 3)

1. Using a slot type screwdriver, loosen idler screw, taking care not to lose lock washer under idler roll.
2. Insert new idler roll and lock washer onto screw, insuring that idler groove is toward top and lock washer is beneath.
3. Tighten screw until tight.

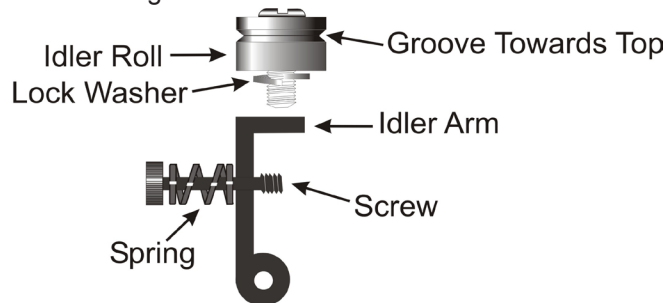

Figure 3

NOTE: Lock washer must be under idler roll or it will not turn freely.

Section C

Options and Accessories

Insulated Drive Roll Kits

Used to prevent preheating of the wire which may soften it and clog the liner. This picking up of current at the drive rolls rather than at the contact tip is usually not a problem unless using too large of a contact tip or excessively oxidized aluminum wire.

Insulated Groove Drive Roll Kit..... **005-0640**

For **.030"** (0.8 mm) dia. aluminum wire. Includes insulated drive roll and idler roll assy.

Insulated Groove Drive Roll Kit..... **005-0716**

For **.035"** (0.9 mm) dia. aluminum wire. Includes insulated drive roll and idler roll assy.

Insulated Groove Drive Roll Kit..... 005-0642

For **.040"** (1.0 mm) dia. aluminum wire. Includes insulated drive roll and idler roll assy.

Insulated Groove Drive Roll Kit..... 005-0718

For **3/64"** (1.2 mm) dia. aluminum wire. Includes insulated drive roll and idler roll assy.

Insulated Groove Drive Roll Kit..... 005-0644

For **.062"** (1.6 mm) dia. aluminum wire. Includes insulated drive roll and idler roll assy.

Replacement Kits

Handle Kit..... 005-0699

Left and right handles, screws and drive roll door, as a replacement for all Python® guns.

Trigger Kit..... 005-0694

Trigger adjustment kit includes a spring and sensitivity adjustment screw replacement for all Python® guns.

Micro Switch Kit..... 005-0701

Replacement micro switch assembly for all Python® guns.

Potentiometer Kit..... 005-0695

Replacement potentiometer assembly for all Python® guns.

Conduit

Flat spiral steel conduit for steel & cored wire

15 ft./4.5m..... **615-0621-15**

25 ft./7.6m..... **615-0621-25**

35 ft./10.7m..... **615-0621-35**

50 ft./15.2m..... **615-0621-50**

Snake Skins

A Snake Skin protective cover is standard on the Millermatic Compatible™ Python®. You may order spare replacement covers to protect the lead assy of the gun when the original becomes damaged or worn. It can easily be replaced in the field by means of a hook and loop type fastener.

Snake Skin Cover 15 ft./4.5m..... **931-0110**

Snake Skin Cover 25 ft./7.6m..... **931-0122**

Snake Skin Cover 35 ft./10.7m..... **931-0132**

Snake Skin Cover 50 ft./15.2m..... **931-0123**

Contact Tips



Heavy Duty Contact Tip - 3/8" Diameter*

Wire Size	Tip ID	Arc	Tip Length	Part No.
.030" (0.8mm)	.040" (1.0mm)	Spray	1.57" (39.9mm)	621-0390-25
		Short	1.82" (46.2mm)	621-0396-25
.035" (0.9mm)	.045" (1.1mm)	Spray	1.57" (39.9mm)	621-0391-25
				621-0391-250†
		621-0391-500††		
.035" (0.9mm)	.045" (1.1mm)	Short	1.82" (46.2mm)	621-0397-25
.045" (1.1mm)	.054" (1.37mm)	Short	1.82" (46.2mm)	621-0398-25
3/64" (1.2mm)	.054" (1.37mm)	Spray	1.57" (39.9mm)	621-0392-25
				621-0392-250†
		621-0392-500††		
3/64" (1.2mm)	.060" (1.5mm)	Spray	1.57" (39.9mm)	621-0393-25**
				621-0393-250†
				621-0393-500††
1/16" (1.6mm)	.074" (1.9mm)	Spray	1.57" (39.9mm)	621-0394-25
		Spray		621-0395-25
	.085" (2.16mm)			

*Use of tip removal tool is recommended

† Also sold in quantities of 250

**This size tip furnished with gun

†† Also sold in quantities of 500

Finned Copper Cups

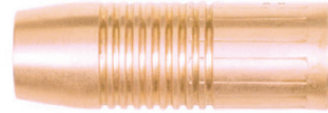

Finned Copper Gas Cups		
Cup Size	Cup I.D.	Part No.
No. 6	3/8" (9.5mm)	621-0248
No. 8	1/2" (12.7mm)	621-0249
No. 10	5/8" (15.8mm)	621-0250*

Heavy Duty Finned Copper Gas Cups		
Cup Size	Cup I.D.	Part No.
10	5/8" (15.8mm)	621-0251
12	3/4" (19.0mm)	621-0252

*Standard - furnished with Air Cooled gun

Barrel



The Millermatic Compatible™ Python® comes standard with a 60° curved barrel. The barrel assembly locks to the Python® body using the patented EZ Lock™ system.

Barrel Removal and Installation

To remove the barrel assembly, loosen the patented EZ Lock™ taper lock nut until it is clear of the threads. Pull barrel out of the gun body.

To replace a barrel assembly, push the barrel assembly into the gun body until it stops. To assure proper seating of the barrel, open the drive/idler roll door in the top of the handle. The rear face of the barrel should now be flush with the gun body. Take care not to damage the o-rings when inserting into the body. Tighten taper lock nut assembly firmly so that barrel cannot rotate while welding.

Barrel Rotation

To rotate a barrel assembly, loosen the patented EZ Lock™ taper lock nut assembly no more than 1 turn. Rotate barrel to the position of your choice and re-tighten taper lock nut assembly firmly so that the barrel cannot rotate.

CAUTION: Do not attempt to weld without the barrel being tightly secured in the gun body, or damage to the barrel or body may result.

Barrel Liner

The standard Teflon liner in the Millermatic Compatible™ Python® barrel is designed for aluminum and other soft wire. A Steel liner is available for steel, cored and other hard wires.

Gun Barrel Liners	
Part Number	Description
931-0137	Teflon Liner Package, 5 pieces
615-0338	Spiral Steel Liner - Steel and Hard Wires
615-0250	Spiral Steel Liner for Tip Extender
621-0424	Tip Extender

NOTE: Contact the factory for more barrel options.

Section D

Maintenance

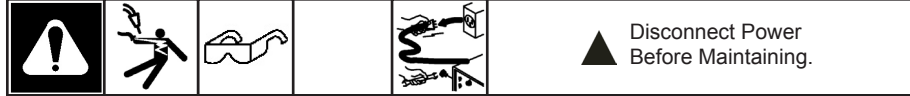

Periodic Maintenance

Maintenance Tools	
Tool	Part No.
Drive Roll Removal Tool	931-0100

Your Millermatic Compatible™ Python® is designed to provide years of reliable service. Maintenance of the gun will normally consist of a general cleaning of the wire guide system, including barrels, drive rolls, and conduits at regular intervals.

Remove spatter build-up from inside of nozzles with a hardwood stick.

The only parts that are subject to normal wear are the conduit, contact tips, nozzles, barrel liners, wire guides, drive and idler rolls. A supply of these parts should be maintained on hand.

The number of units in operation and the importance of minimal down time will determine to what extent spare parts should be stocked on hand. See the recommended spare parts list for the most commonly replaced parts.

If repairs do become necessary, qualified shop maintenance personnel can easily replace any part.

Reference the table below for suggested Maintenance Tools used with the Millermatic Compatible™ Python® welding gun.

Testing The Gun

Reference the "X" clocked Amphenol diagram on the Millermatic Compatible™ Python® electrical diagram for information about pin-outs and locations.

Motor Check

Remove the connector from the cabinet.

Using the Amphenol connector, check the resistance across pins "C" and "B" (motor leads). The resistance across the motor should be between **5 - 10 ohms** as the potentiometer is turned.

If an open circuit or short exist, check the motor leads and motor independently.

Testing the Gun Potentiometer

Using the amphenol connector, check the resistance across pin "F" (wiper) and pin "E". The resistance should vary from **0 - 5K ohms** as the potentiometer is turned.

Check the resistance across pin "F" (wiper) and pin "H". The resistance should vary from **5K - 0 ohms** as the potentiometer is turned.

Testing the Micro Switch

Using the amphenol connector, check for continuity across pins "D" and "G" when the trigger is pressed.

Recommended Spare Parts

Listed in the table below is the factory recommendation of the necessary spare parts which should be kept on hand for maintaining proper operation of the Millermatic Compatible™ Python® welding gun.

Recommended Spare Parts List		
Qty.	Part Number	Description
1	615-0602-15	15' Conduit
1	615-0602-25	25' Conduit
1	615-0602-35	35' Conduit
1	615-0602-50	50' Conduit
2	005-0695	Potentiometer Assy Kit
2	005-0694	Trigger Assy Kit
1	005-0699	Handle Kit
2	005-0701	Micro-Switch Assy Kit
10	511-0101	Drive Roll
5	005-0686	Idler Roll Kit
2	931-0137	Liner Package - 5 pieces each

This list, in no way, indicates that these parts are more likely to fail or cause equipment damage. This is not an indication of premature failure or defect in manufacture of said parts.

Section E

Troubleshooting Guide

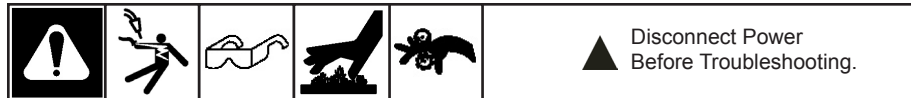

To aid in troubleshooting problems with your welding equipment, it is best to understand the basic theory of operation for this Push-Pull System. The slave motor in the feeder runs at a fast, constant speed, but has very low torque. It is always trying to feed more wire than the gun motor wants, and when the motor gets all it wants, it slows the slave motor, preventing a bird's nest. Because of the low torque produced by the slave motor, a brake system is used to prevent wire overrun rather than tension. The drag adjustment in the feeder is used simply to keep the wire slightly taut, so it will not pull off the spool while feeding wire.

The high torque 24VDC gun motor is controlled by a solid state speed control located in the feeder, and a pot located in the gun. The gun motor, potentiometer, and micro switch are connected to the cabinet/control box via a control cable and Amphenol connector. If this cable becomes damaged, a variety of symptoms can occur, depending on which wire(s) break. To test, check each wire for continuity and shorts.

Remember, the micro switch in the gun activates both the slave motor and gun motor circuits in the cabinet. Therefore, if the slave motor and brake solenoid operate, but the gun does not, look more toward the gun motor's 24VDC circuits, speed control, control cable, or the gun motor. If nothing operates, look more toward the slave motor's input, micro switch leads, or micro switch.

Troubleshooting Table

Symptoms	Cause	Remedy
No wire feed at gun, feeder not operating, i.e. no slave motor or brake solenoid.	Circuit breaker in feeder/control box open.	Reset.
	Micro-switch defective/not being activated.	Replace switch. Check switch for operation.
	Broken electrical cable.	Check micro-switch wires for continuity.
No wire feed at gun, feeder operating properly.	Circuit breaker in feeder/control box open.	Check motor leads for short. Reset.
	Bad potentiometer.	Check potentiometer with meter.
	Broken electrical cable.	Check motor and potentiometer wires for continuity.
	Bad speed control/PCB.	See specific feeder/control box owner's manual for speed control operation.
Wire feeds, but welding wire is not energized.	Loose or no cable connections.	Check all power connections.
	Contact control cable loose or in wrong position.	Check power supply owner's manual for location and type of contactor signal required.
	Welding power source.	Check power source.
Wire feeds erratically.	Dirty or worn conduit.	Blow out or replace conduit.
	Wrong size contact tip.	See contact tip table.
	Idler roll stuck.	Check for lock washer under idler roll, or replace if damaged.
Wire feeds one speed only.	Bad potentiometer.	Check with meter.
	Broken electrical cable.	Check potentiometer wires for continuity or short.
	Bad speed control.	See specific feeder/control owner's manual for speed control operation.
Wire walks out of drive rolls.	Idler roll upside-down.	Place groove in idler roll toward top.
	Rear wire guide missing.	Replace wire guide.

Consult wire feeder and welding power supply owners manuals for further problem solving solutions.

Section F

Appendices

Millermatic Compatible™ Python® Diagrams / Parts List

Exploded Parts View.....	10
Complete Parts List	11
Front Body Assembly Parts View.....	12
Barrel Assembly Parts View.....	13
Power/Gas Connector Parts View	14
Electrical/Connector Pinout	15

Millermatic Compatible™ Python®

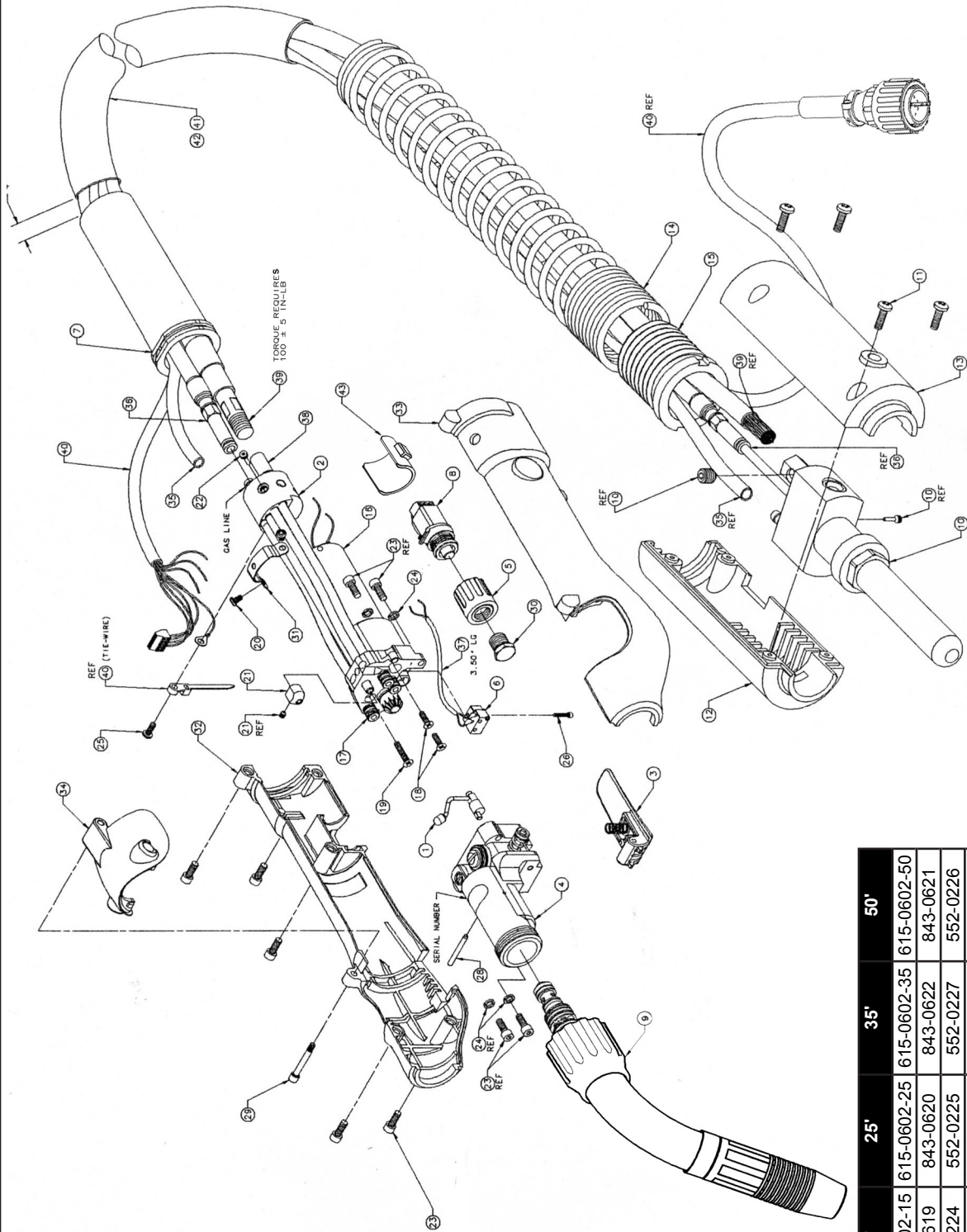

No.	Description	15'	25'	35'	50'
36	Conduit	615-0602-15	615-0602-25	615-0602-35	615-0602-50
39	Power Cable	843-0619	843-0620	843-0622	843-0621
35	Gas Hose	552-0224	552-0225	552-0227	552-0226
40	Control Cable	843-0624	843-0625	843-0627	843-0626
43	Snake Skin	931-0110	931-0122	931-0132	931-0123

Millermatic Compatible™ Python Head Assembly

No.	Qty.	Part No.	Description	No.	Qty.	Part No.	Description
1	1	002-0629	Assy Cam Idler Arm	23	9	328-0012	Scr Shc 6-32 x 3/8
2	1	002-0631	Rear Body	24	4	333-0005	Wshr Spr LK #6
3	1	003-0857	Assy Trigger	25	1	336-0020	Scr Ph Phil 4-40 x 5/16 SST
4	1	003-2108	Assy Front Body	26	1	338-0153	Scr Shc 1-72
5	1	003-2125	Assy Knob Pot	27	6	411-0045	Tie Wrap
6	1	005-0701	Micro Swx Kit	28	1	421-0018	Pin Dowel 3/32 x 7/8 SST
7	1	003-2153	Assy Gun Boot	29	1	431-1622	Scr Shoulder 1/8 x 4/40
8	1	005-0695	Assy Speed Control Pot Kit	30	1	431-1637	Screw Hex 3/8-20 x 3/8
9	1	003-2147	Assy Barrel 60° AW	31	1	435-1585	Strap Motor
10	1	003-2241	Assy Power Pin Millermatic Compatible™	32	1	005-0699	Handle Kit: Includes line items 28, 29, and 34
11	4	336-0247	Screw, K40X12 Pan HD-Phil ST	33			
12	1	437-0285	Housing, Pwr Pin Right Handle	34	1	437-0253	Door Molded
13	1	437-0286	Housing, Pwr Pin Left Handle	35	1	SEE TABLE	Assy Gas Hose
14	1	419-0101	Strain Relief Spring	36	1	SEE TABLE	Assy Conduit
15	1	437-0287	Spring Retainer	37	0.30 ft	737-0048	Tube Insulation 9 AWG, Clear
16	1	211-0077	Motor Pittman	38	1	751-0020	Cap Plug 0.218 ID x 0.50 LG
17	6	303-0096	O-Ring, .145 ID x .07 W	39	1	SEE TABLE	Assy Power Cable
18	2	319-0254	Scr FH Phil 82 4-40 x 3/8 SST	40	1	SEE TABLE	Assy Control Cable
19	1	319-0258	Scr FH Phil 82 4-40 x 5/8 SST	41	1	SEE TABLE	Snake Skin
20	2	320-0084	Scr Button 4-40 x 3/16 ST	42	2	261-0094	Wrap Spiral Cord
21	1	003-2209	Assy Guide Wire	43	1	437-0268	Knob Cover
22	1	321-1104	Set Screw Mod 8-32				

Millermatic Compatible™ Python® Front Body Assembly 003-2108

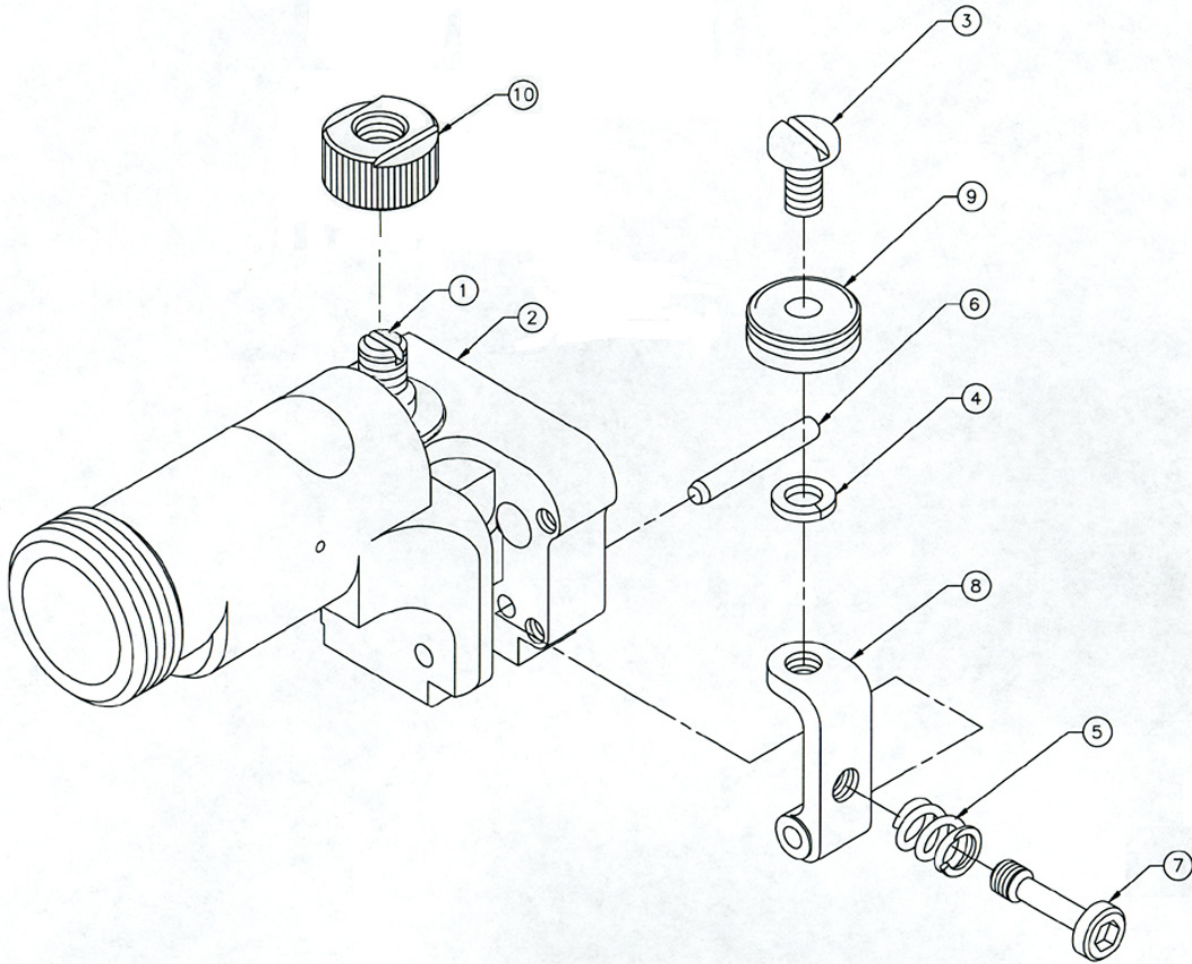

Items 3, 4 & 9 available
as package kit:
P/N 005-0686

Python® Front Body Assembly			
No.	Qty.	Part No.	Description
1	-	-	Not available separately
2	-	-	
3*	1	325-0206	10-24 x 3/8 PH Screw
4*	1	333-0082	# 10 Lock Washer
5	1	419-0092	0.29 x 0.047 x 0.32 Comp. Spring
6	1	421-0525	1/8 x 7/8 SST Dowel Pin
7	1	431-1663	Idler Adjusting Screw
8	1	431-1598	Idler Arm
9	1	511-0001*	Idler Wire Feed Assembly
10	1	511-0101	Drive roll

* Items 3, 4 & 9 available as package kit: **Part number 005-0686**

Millermatic Compatible™ Python® Barrel Assembly 003-2147

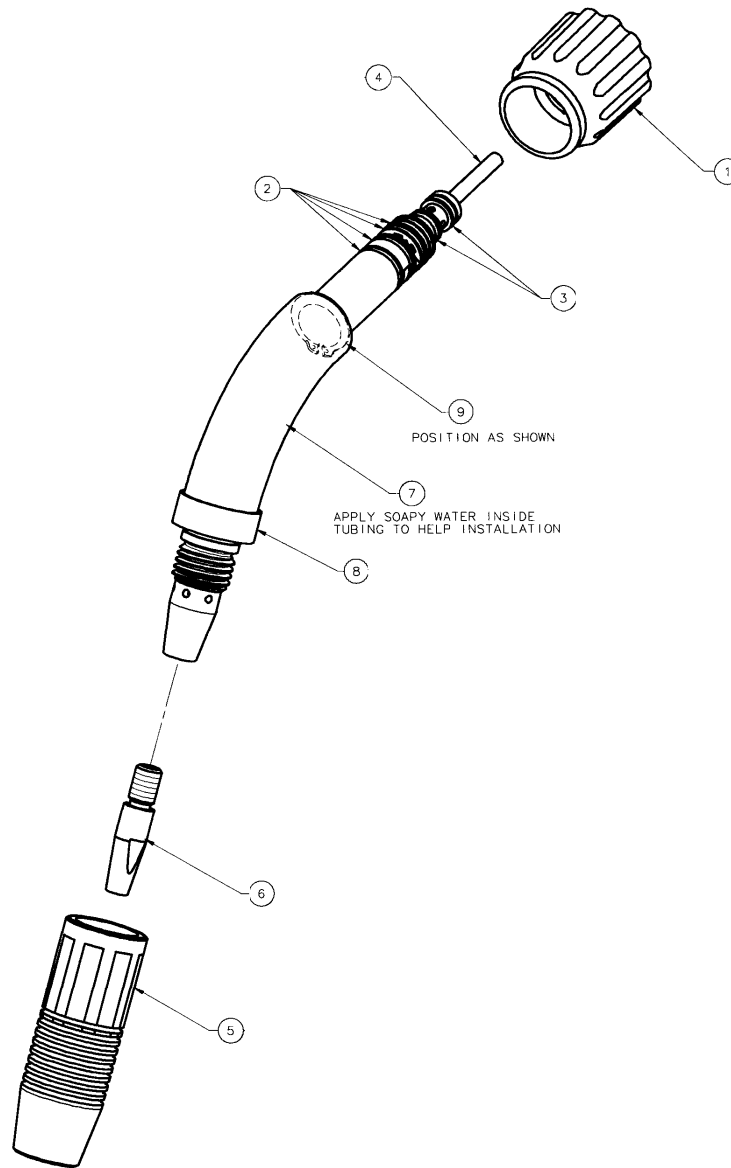

Air/Liquid Cooled 60° Curved Barrel Assembly

No.	Qty.	Part No.	Description
1	1	003-2213	Assy Taper Lock
2	4	303-0010	O-Ring 0.489 I.D. x .070 Width
3	2	303-0094	O-Ring 0.301 I.D. x .070 Width
4	1	931-0137	Liner Package, 5 pieces
5	1	621-0250	Assy Cup CPR Finned #10
6	1	621-0393	Tip HD Spray .060
7	1	005-0696	Insulator Replacement Kit
8	1	431-1774	Cup Insulator
9	1	313-0091	Retaining Ring 5/8 Shaft

Millermatic Compatible™ Python® Power/Gas Connector 003-2241

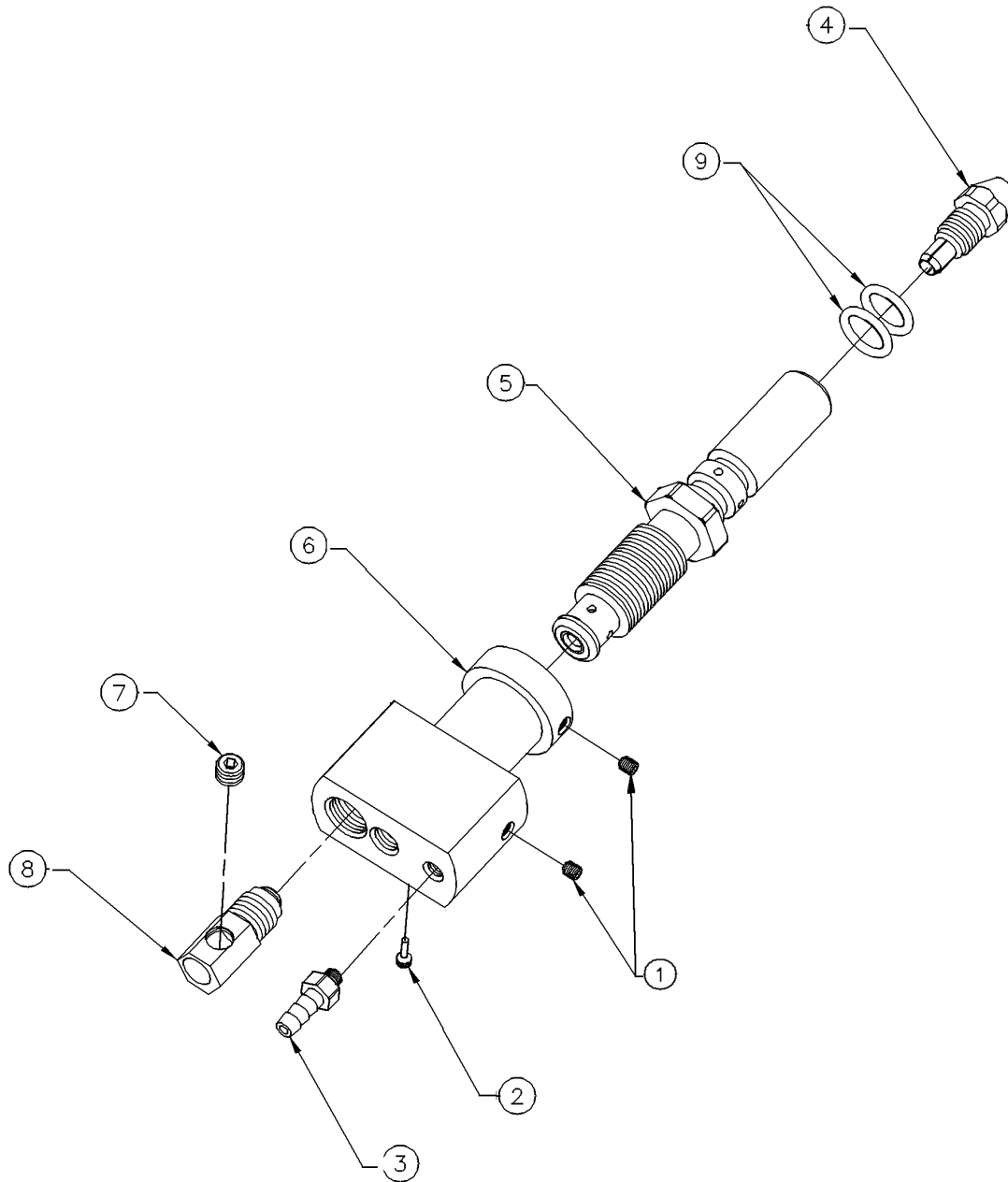

Millermatic Compatible™ Python® Power/Gas Connector			
No.	Qty.	Part No.	Description
1	2	321-0070	Set Screw, 10-32
2	1	321-1104	Set Screw, 8-32 Mod Conduit
3	1	753-0089	Gas Hose Barbed Fitting
4	1	431-1742	Outlet Wire Guide .030 - 1/16
5	1	153-1210	Power Pin Assy
6	1	431-1743	Power Gas Connector, Mod.
7	1	321-0104	Set Screw, 5/16-18 x 1/4
8	1	753-0088	Power Weld Fitting
9	2	303-0102	O-Ring, 0.487 ID x .103 Width

Millermatic Compatible™ Python® Electrical Schematic/Connector Pinout

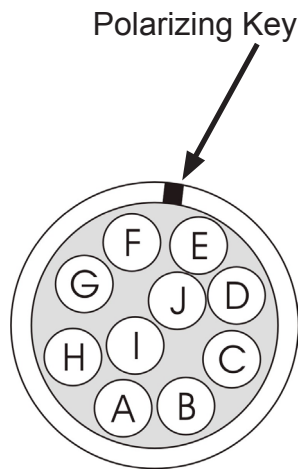

"X" Clocked Amphenol Connector
Viewed from back of connector

	WARNING
	<ul style="list-style-type: none"> • Do not touch live electrical parts. • Disconnect input power or stop engine before servicing. • Do not operate with covers removed. • Have only qualified persons install, use, or service this units.
ELECTRIC SHOCK HAZARD	

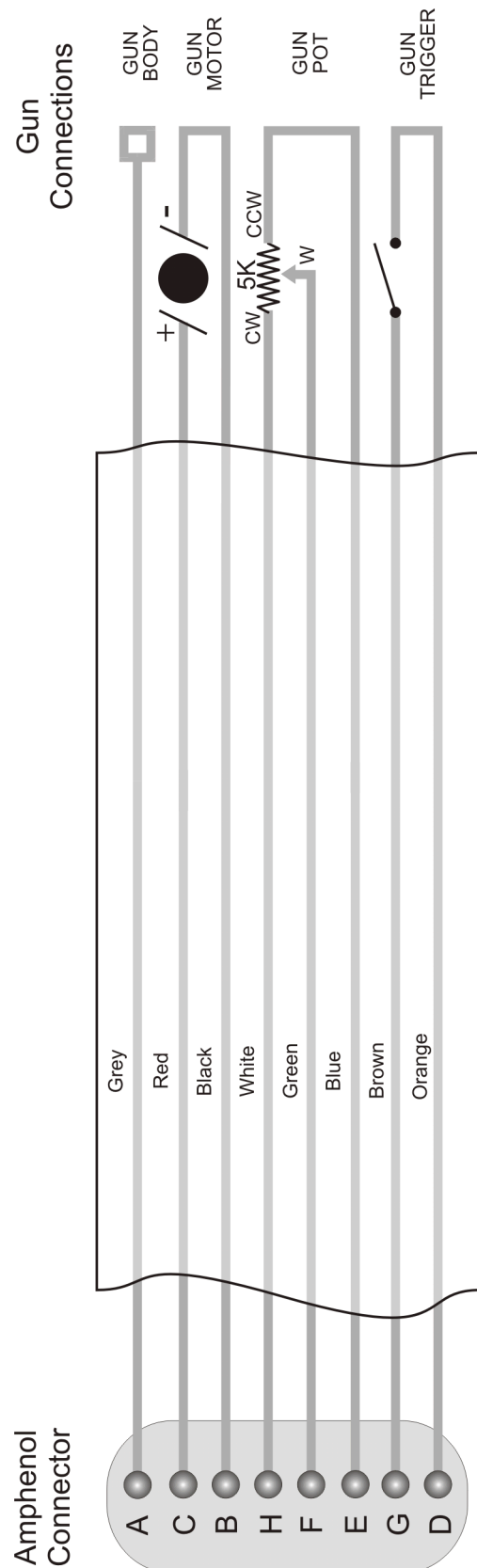

This page intentionally blank

LIMITED WARRANTY

Effective November 1, 2007

This warranty supersedes all previous MK Products warranties and is exclusive, with no other guarantees or warranties expressed or implied.

LIMITED WARRANTY - MK Products Inc., Irvine, California warrants that all new and unused equipment furnished by MK Products is free from defects in workmanship and material as of the time and place of delivery by MK Products. No warranty is made by MK Products with respect to trade accessories or other items manufactured by others. Such trade accessories and other items are sold subject to the warranties of their respective manufacturers, if any.

MK Products' warranty does not apply to components having normal useful life of less than one (1) year, such as relay points, wire conduit, tungsten, and welding gun parts that come in contact with the welding wire, including gas cups, gas cup insulators, and contact tips where failure does not result from defect in workmanship or material.

MK Products shall, exclusively remedy the limited warranty or any duties with respect to the quality of goods, based upon the following options:

- (1) repair
- (2) replacement
- (3) where authorized in writing by MK Products, the reasonable cost of repair or replacement at our Irvine, California plant.

As a matter of general policy only, MK Products may honor an original user's warranty claims on warranted equipment in the event of failure resulting from a defect within the following periods from the date of delivery of equipment to the original user:

- 1. **Power Supplies and Wire Feed Cabinets3 years**
- 2. **Weldheads, Positioners, Prince XL and Prince XL Spool Guns, Python, CobraMAX, Cobra SX, Cobra MX 1 year**
- 3. **Sidewinder Spool Gun, Prince SG Spool Guns, Modules180 days**
- 4. **Repairs/Exchanges/Parts 90 days**

Classification of any item into the foregoing categories shall be at the sole discretion of MK Products. Notification of any failure must be made in writing within 30 days of such failure.

A copy of the invoice showing the date of sale must accompany products returned for warranty repair or replacement.

All equipment returned to MK Products for service must be properly packaged to guard against damage from shipping. MK Products will not be responsible for any damages resulting from shipping.

Normal surface transportation charges (one way) for products returned for warranty repair or replacement will be borne by MK Products, except for products sold to foreign markets.

ANY EXPRESS WARRANTY NOT PROVIDED HEREIN AND ANY IMPLIED WARRANTY, GUARANTY, OR REPRESENTATION AS TO PERFORMANCE, AND ANY REMEDY FOR BREACH OF CONTRACT WHICH, BUT FOR THIS PROVISION, MIGHT ARISE BY IMPLICATION, OPERATION OF LAW, CUSTOM OF TRADE, OR COURSE OF DEALING, INCLUDING ANY IMPLIED WARRANTY OF MERCHANTABILITY OR OF FITNESS FOR PARTICULAR PURPOSE, WITH RESPECT TO ANY AND ALL EQUIPMENT FURNISHED BY MK PRODUCTS, IS EXCLUDED AND DISCLAIMED BY MK PRODUCTS.

EXCEPT AS EXPRESSLY PROVIDED BY MK PRODUCTS IN WRITING, MK'S PRODUCTS ARE INTENDED FOR ULTIMATE PURCHASE BY COMMERCIAL/INDUSTRIAL USERS AND FOR OPERATION BY PERSONS TRAINED AND EXPERIENCED IN THE USE AND MAINTENANCE OF WELDING EQUIPMENT AND NOT FOR CONSUMERS OR CONSUMER USE. MK PRODUCTS' WARRANTIES DO NOT EXTEND TO, AND NO RE-SELLER IS AUTHORIZED TO EXTEND MK PRODUCTS' WARRANTIES TO ANY CONSUMER.

USE OF OTHER THAN *GENUINE* MK PRODUCTS' CONSUMABLES, PARTS, AND ACCESSORIES MAY INVALIDATE YOUR PRODUCT WARRANTY.



16882 Armstrong Ave.
Irvine, CA 92606
Tel (949)863-1234
Fax (949)474-1428
www.mkproducts.com

November 1, 2007



PRODUCTS

16882 Armstrong Ave.

Irvine, CA 92606

Tel (949)863-1234 Fax (949)474-1428

www.mkproducts.com